

# FANTIC MOTOR



TRIAL 200

**A-1**

NUMERO CATALOGO 350.94.5220  
NUMERO CATALOGUE 350.94.5220  
CATALOG NUMBER 350.94.5220  
CATALOG NUMBER 350.94.5220

**FANTIC  
FMOTOR**



- TRIAL 200 -

CATALOGO PARTI DI RICAMBIO

11-1979

CATALOGUE DE PIECES DE RECHANGE

11-1979

SPARE PARTS CATALOG

11-1979

ERSATZTEILE KATALOG

11-1979

**A2**

DATI D'IDENTIFICAZIONE  
DONNEES D'IDENTIFICATION  
IDENTIFICATION VEHICLE  
LAGE VON TYPSCHEID RAHMENNUMMER

13-2810

PROVALETTA DAVINO

13-1810

TIPO

COMPONENTI PARTI



- TRIAL 200 -

TIPO DI VEICOLO E NUMERO DI TELAIO  
MODELE DE VEHICULE ET NUMERO DE CADRE  
VEHICLE TYPE AND FRAME NUMBER  
FAHRZEUG-TYP UND RAHMENNUMMER

FANTIC 350  
DGM 19461 OM  
☆ 0001001☆



N°  
 Tav.  
 P+N° ...  
 A+N° ...  
 P Tav.E3/2  
 A Tav.E3/1  
 ↑ 0001500 ↑  
0001501 ↑  
(A+B+...) N°  
 190.01.5200 }  
 191.01.5200 }  
 319.11.5000 +

322.47.5210+2/10  
 155.43.8030 ≠ 0,4  
 310.15.5140 d.  
 310.15.5150 s.  
~~250.01.5000~~

Z=...  
 N° ...  
 V

W  R  
 SG  
 SP  
 a  
 P  
 1  
 2  
 3  
 4  
 5  
 6  
 SD  
 M 6x16  
 M 6  
 Ø 6x18

- = Numéro de pièce
- = Planche
- = Numéro de pièce nouveau montage
- = Numéro de pièce ancien montage
- = Planche E3/2 regroupant des pièces nouveau montage
- = Planche E3/1 regroupant des pièces ancien montage
- = La planche (ou la pièce) est applicable jusqu'à le véhicule numéro de cadre 0001500
- = La planche (ou la pièce) est applicable depuis le véhicule numéro de cadre 0001501
- = Collection de pièces comprenant les pièces A+B+... illustrées par la planche
- = Pièces montées en parallèle
- = Equipements spéciaux d'exportation (voir au bas de la planche et à la page A7 l'application en fonction des destinations)
- = Pièce cote majorée de 2/10
- = Pièce d'une épaisseur de 0,4 mm.
- = Pièce droite } dans le sens de marche
- = Pièce gauche }
- = Pièces remplacées ou supprimées
- = Numéro de cames
- = Après épauement prévoir N° ...
- = Volt
- = Watt
- = En option
- = Jeu de joint complète
- = Jeu de presse-étoupe moteur complète
- = Avant
- = Arrière
- = 1ère vitesse
- = 2e vitesse
- = 3e vitesse
- = 4e vitesse
- = 5e vitesse
- = 6e vitesse
- = Jeu de decal véhicule complète
- = Diamètre et longueur des vis d'usage commun pas fournies pour rechange
- = Diamètre des écrous d'usage commun pas fournies pour rechange
- = Diamètre intérieur (6) et extérieur (18) des rondelles d'usage commun pas fournies pour rechange





**B**

TRIAL 200

11 - 1979

INDICE GRAFICO GENERALE  
 REPERTOIRE ILLUSTRÉ GENERAL  
 GENERAL TABLE  
 ALLGEMEINES GRAPHISCHES VERZEICHNIS

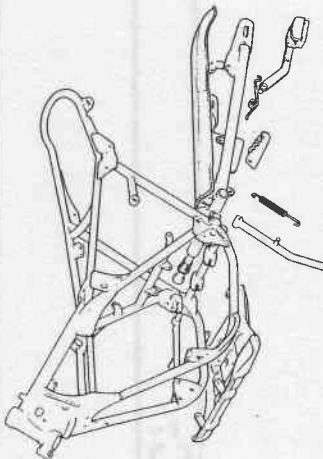
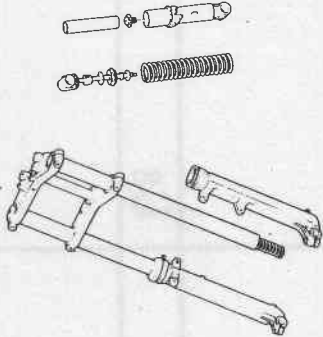
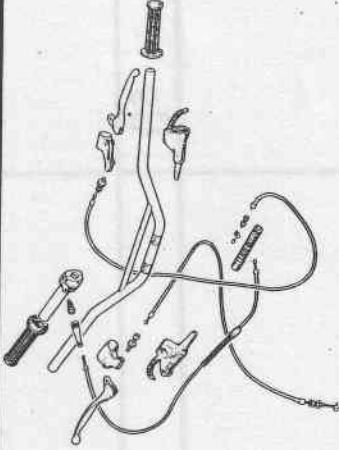
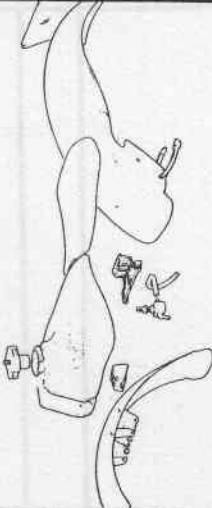
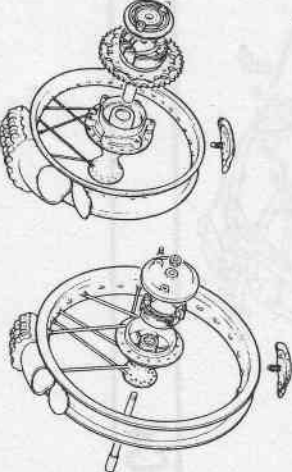
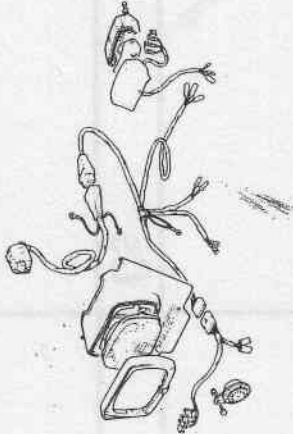
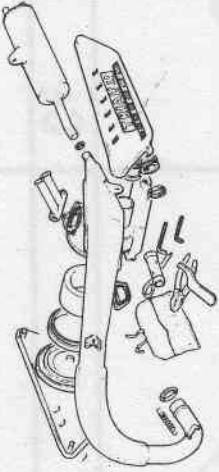
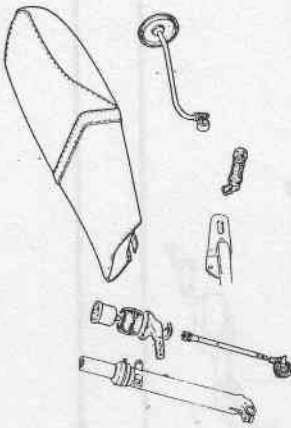
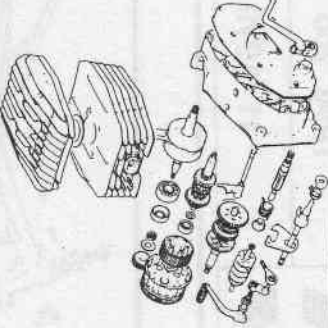
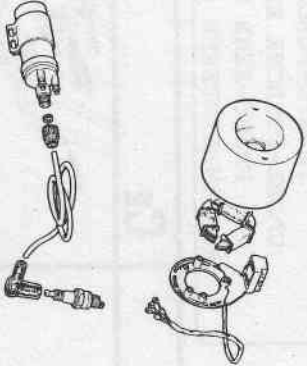
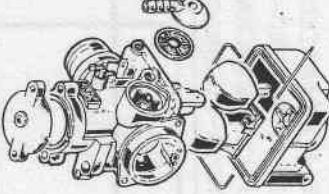
**FANTIC  
FMOTOR**

|   |   |   |   |
|---|---|---|---|
| <b>C</b><br>   | <b>D</b><br>   | <b>E</b><br>  | <b>F</b><br>    |
| <b>G</b><br>  | <b>H</b><br>  | <b>L</b><br> | <b>M</b><br>  |
| <b>N</b><br> | <b>O</b><br> | <b>P</b><br> | <b>Q</b><br> |

**C**

TRIAL 200

11 - 1979

TELAIO-FORCELLONE-CAVALLETTO-POGGIAPIEDI-TENDICATENA  
 CADRE-FOURCHE ARRIERE-BEQUILLE-REPOSE-PIED-TENDEUR DE CHAINE  
 FRAME-REAR FORK-PROP STAND-FOOTREST-CHAIN TENSIONER  
 RAHMEN-HINTERER SWINGARM-KIPPSTANDER-FUSSRASTE-KETTENSPIANNER

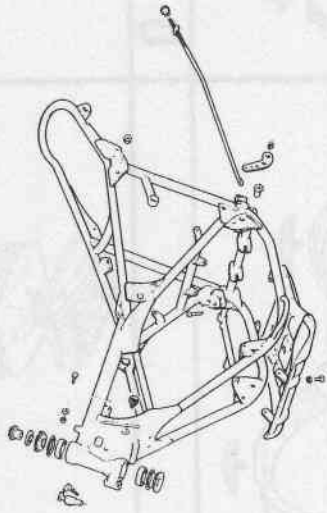
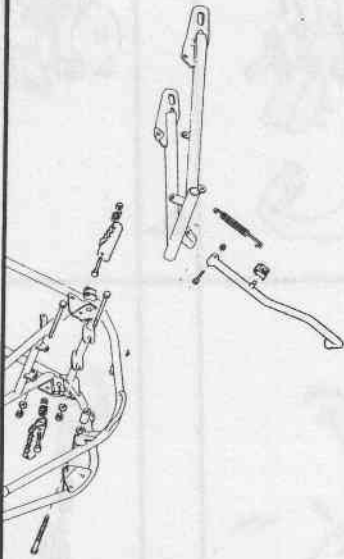
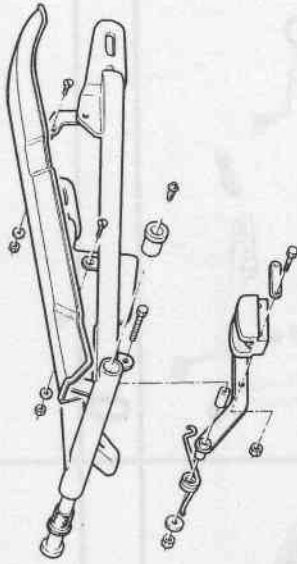
**FANTIG  
FMOTOR****C1****C2****C3****C4****C5****C6****C7****C8****C9**

11-1979

**B**

VERMIDDELS ONZE VERKOPERS

OPGEZOND WORDEN

VERKOPERS VAN DE

FANTIG FMOTOR

**FANTIG  
FMOTOR**

**C1**

TRIAL 200

11 - 1979

**C**

1/1

**FANTIC  
FMOTOR**

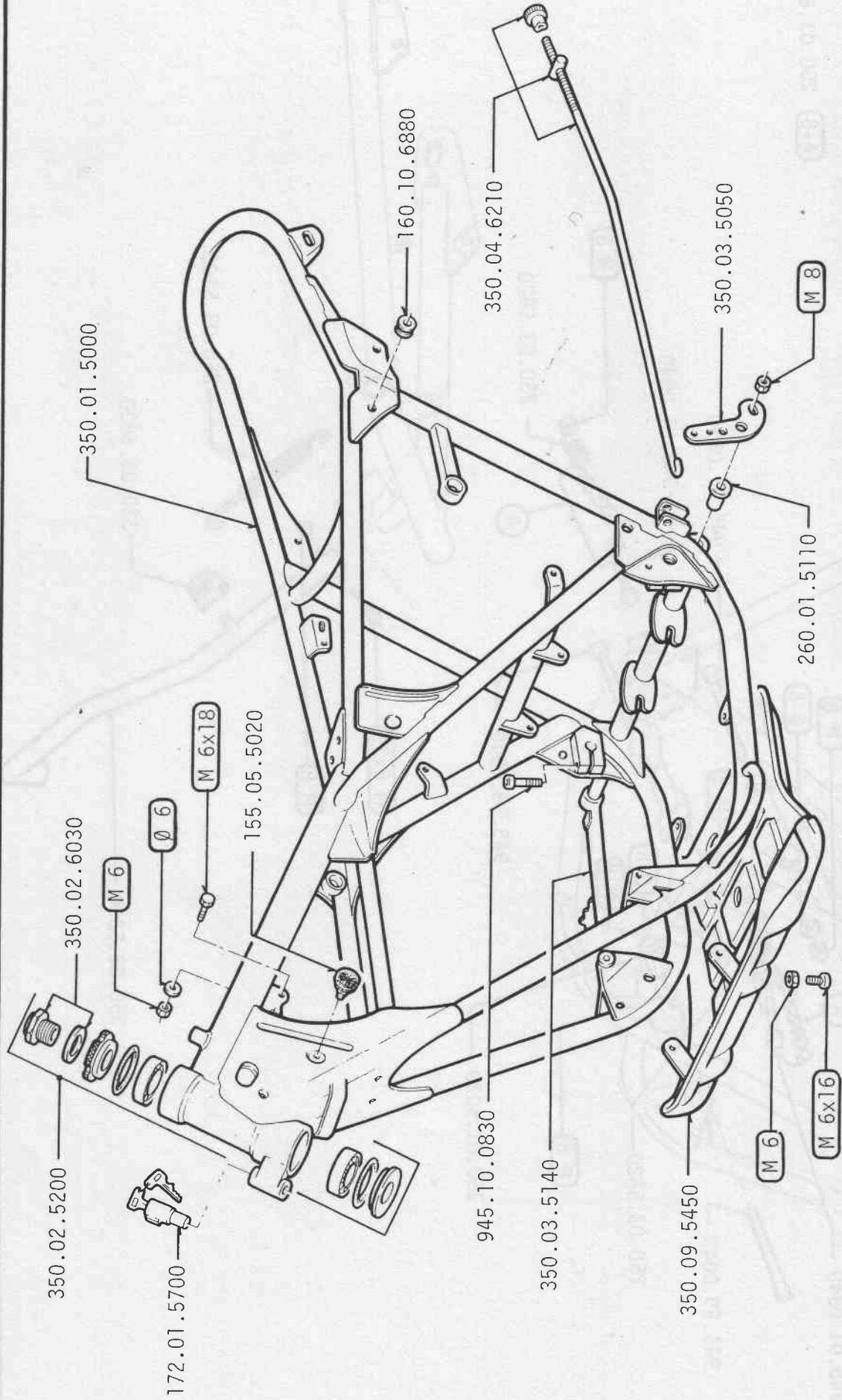

# C2

TRIAL 200

11 - 1979

# C

2/1

# FANTIC FMOTOR

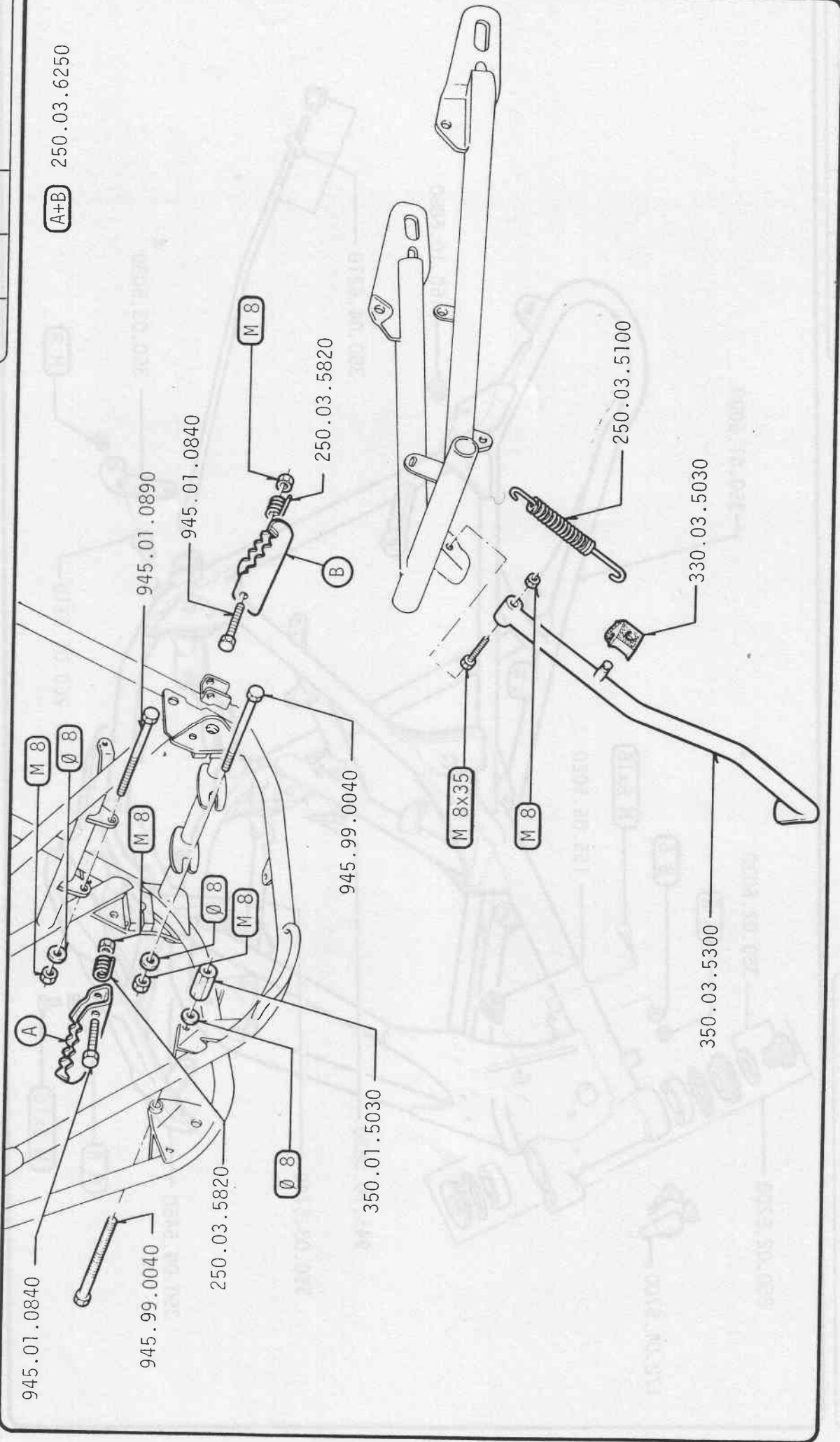

(A+B) 250.03.6250

# C4

11 - 1979

# C

2/1

# FANTIC FMOTOR

**C3**

TRIAL 200

11 - 1979

**C**

3/1

**FANTIC  
FMOTOR**

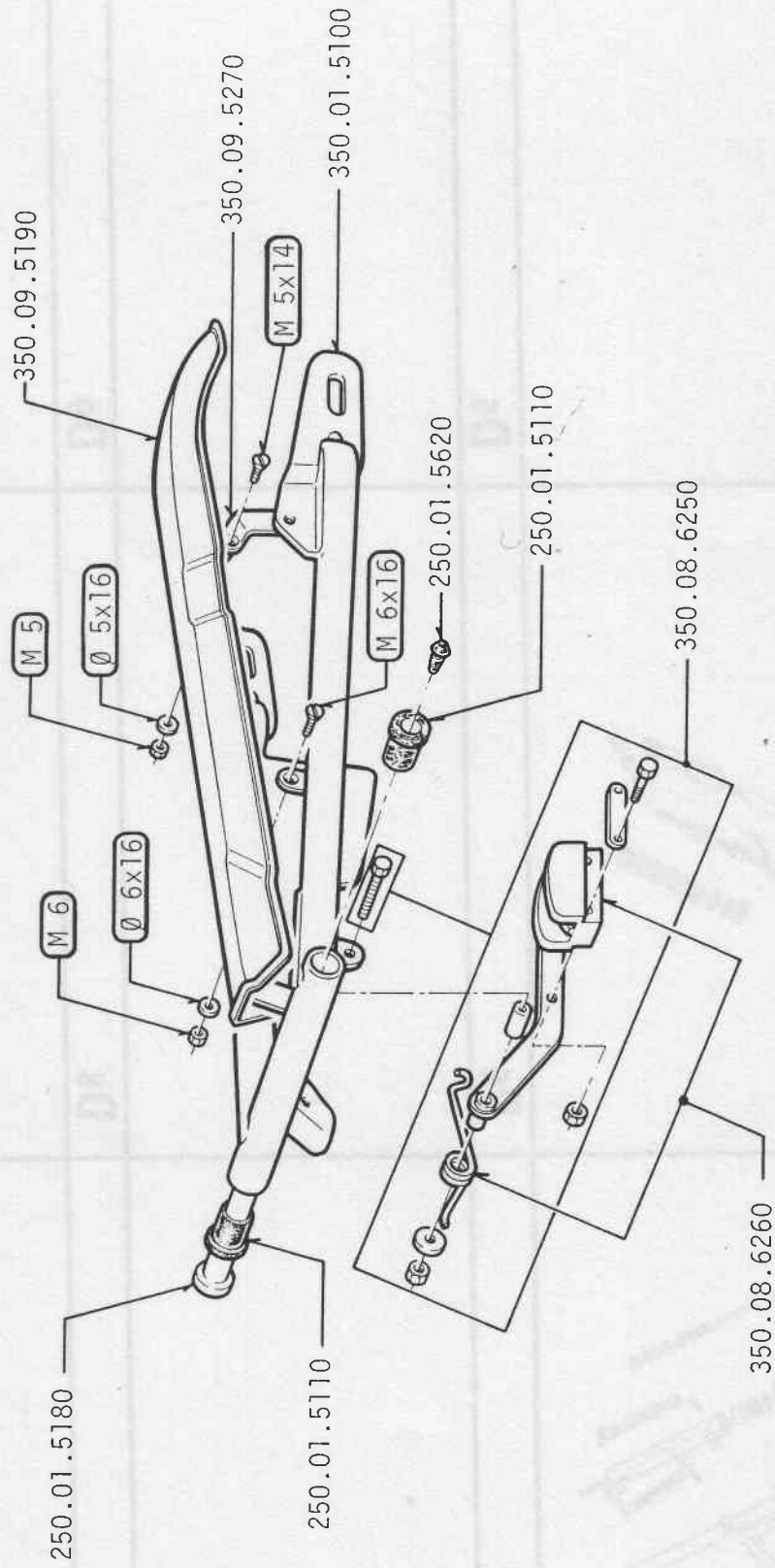

**D**

TRIAL 200

11 - 1979

FORCELLA ANTERIORE - AMMORTIZZATORI POSTERIORI  
 FOURCHE AVANT - AMORTISSEUR ARRIER  
 FRONT FORK - REAR SHOCK ABSORBER  
 VORDERE RADGABEL - HINTERER STROSSDÄMPFER

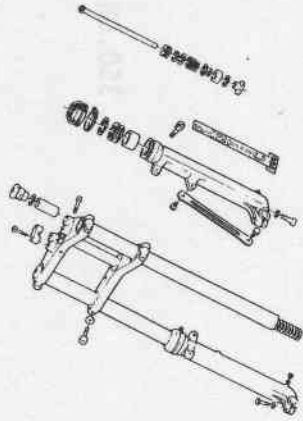
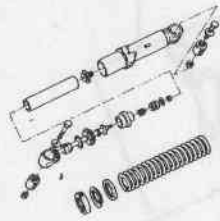
**FANTIC  
FMOTOR****D1****D2****D3****D4****D5****D6****D7****D8****D9****C3**13-1010  
ASVT 500**FANTIC  
FMOTOR**

**D1**

TRIAL 200  
11 - 1979

**D**

1/1

**FANTIG  
FMOTOR**

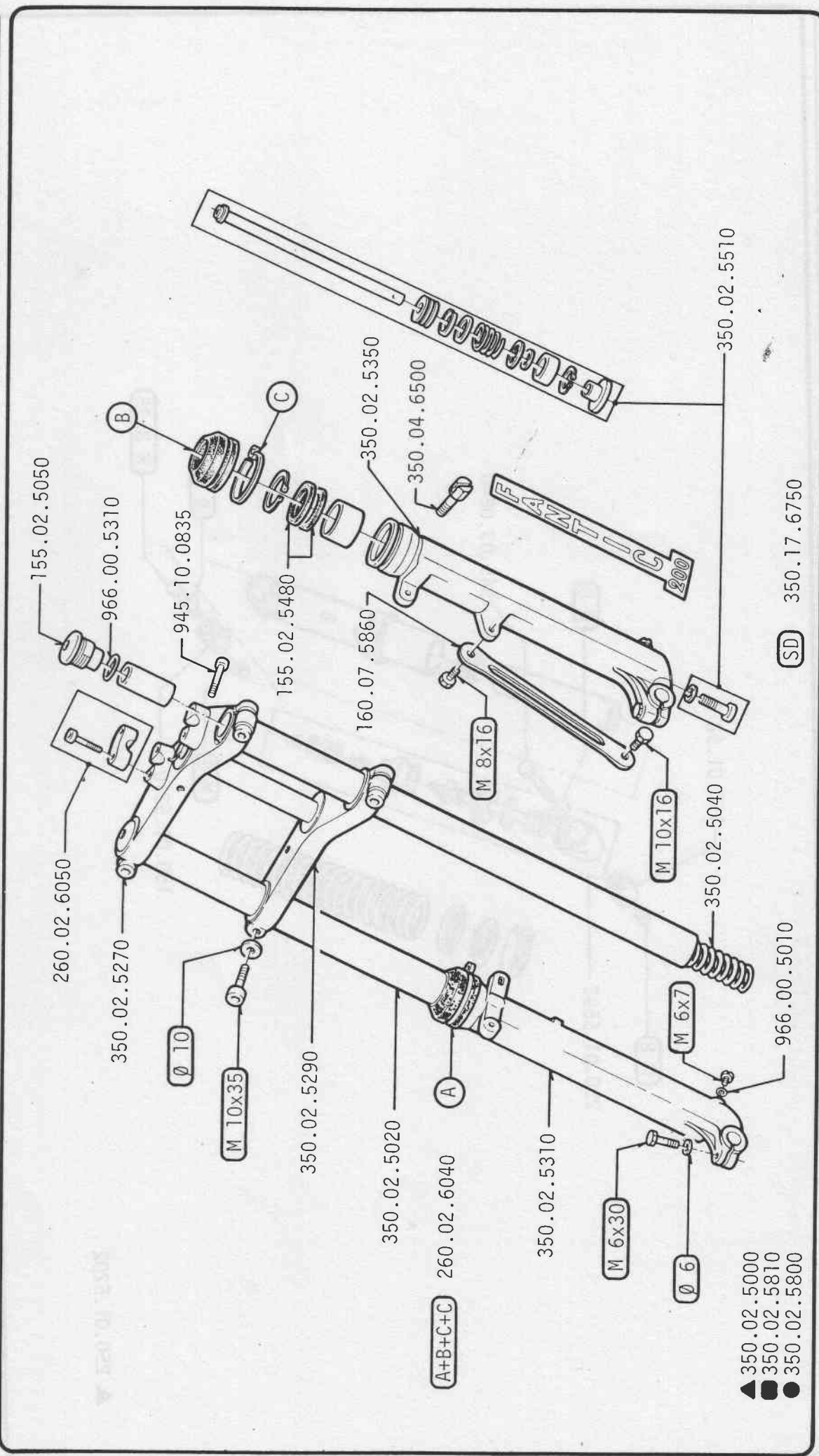

- ▲ 350.02.5000
- 350.02.5810
- 350.02.5800

**(SD)** 350.17.6750

- ▲ Forcella anteriore completa
- Gamba destra forcella completa
- Gamba sinistra forcella completa
- ▲ Fourche avant complète
- Jambe droite complète
- Jambe gauche complète
- ▲ Fork complet
- Fork leg complete R/H
- Fork leg complete L/H
- ▲ Vordere Radgabel Komplet
- Rechtes Gabelbein Komplet
- Linkes Gabelbein Komplet

**D2**

TRIAL 200

11 - 1979

**D**

2/1

**FANTIC  
FMOTOR**

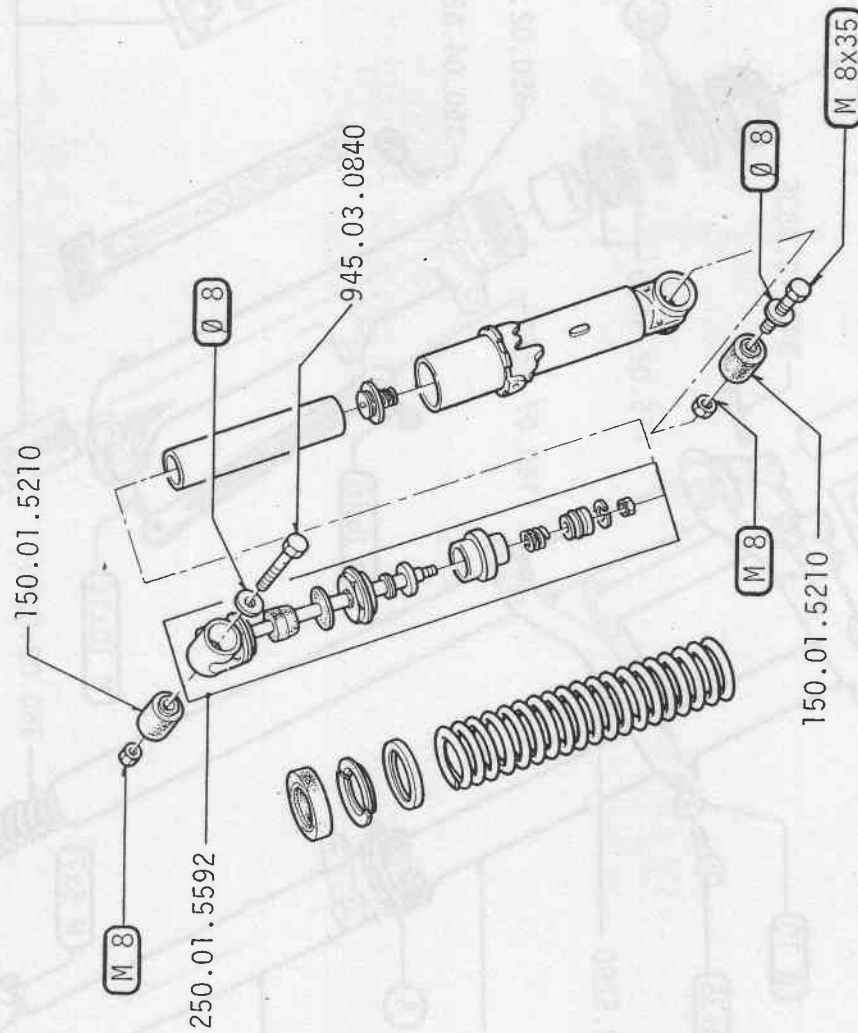

▲ 250.01.5202

▲ Ammortizzatore completo ▲ Amortisseur complet

▲ Rear shock absorber complet

▲ Hinterer Stossdämpfer Komplet

**E**

TRIAL 200

11-1979

MANUBRIO - COMANDI - TRASMISSIONI  
GUIDON - COMMANDES - TRANSMISSIONS  
HANDLEBAR - CONTROLS - CABLES  
LENKER - BETÄTIGUNGS - ZUGS**FANTIC  
FMOTOR**

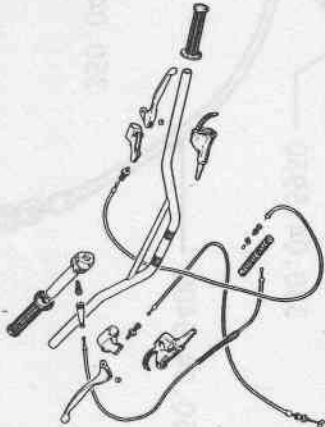
|  |           |           |
|--|-----------|-----------|
| <b>E1</b><br> | <b>E2</b> | <b>E3</b> |
| <b>E4</b>  | <b>E5</b> | <b>E6</b> |
| <b>E7</b>  | <b>E8</b> | <b>E9</b> |



**F**

TRIAL 200

11 - 1979

SERBATOIO-SELLA-PARAFANGHI  
RESERVOIR-SELLE-GARDE-BOUE  
FUEL TANK-SEAT-MUDGUARDS  
KRAFTSTOFFBEHALTER-SATTEL-KOTFLUGEL

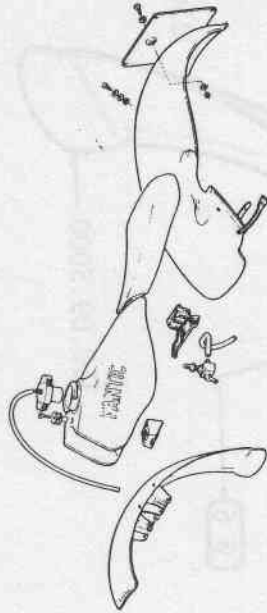
**FANTIC  
FMOTOR****F1****F2****F3****F4****F5****F6****F7****F8****F9**

# F1

TRIAL 200

11 - 1979

# F

1/1

# FANTIC FMOTOR

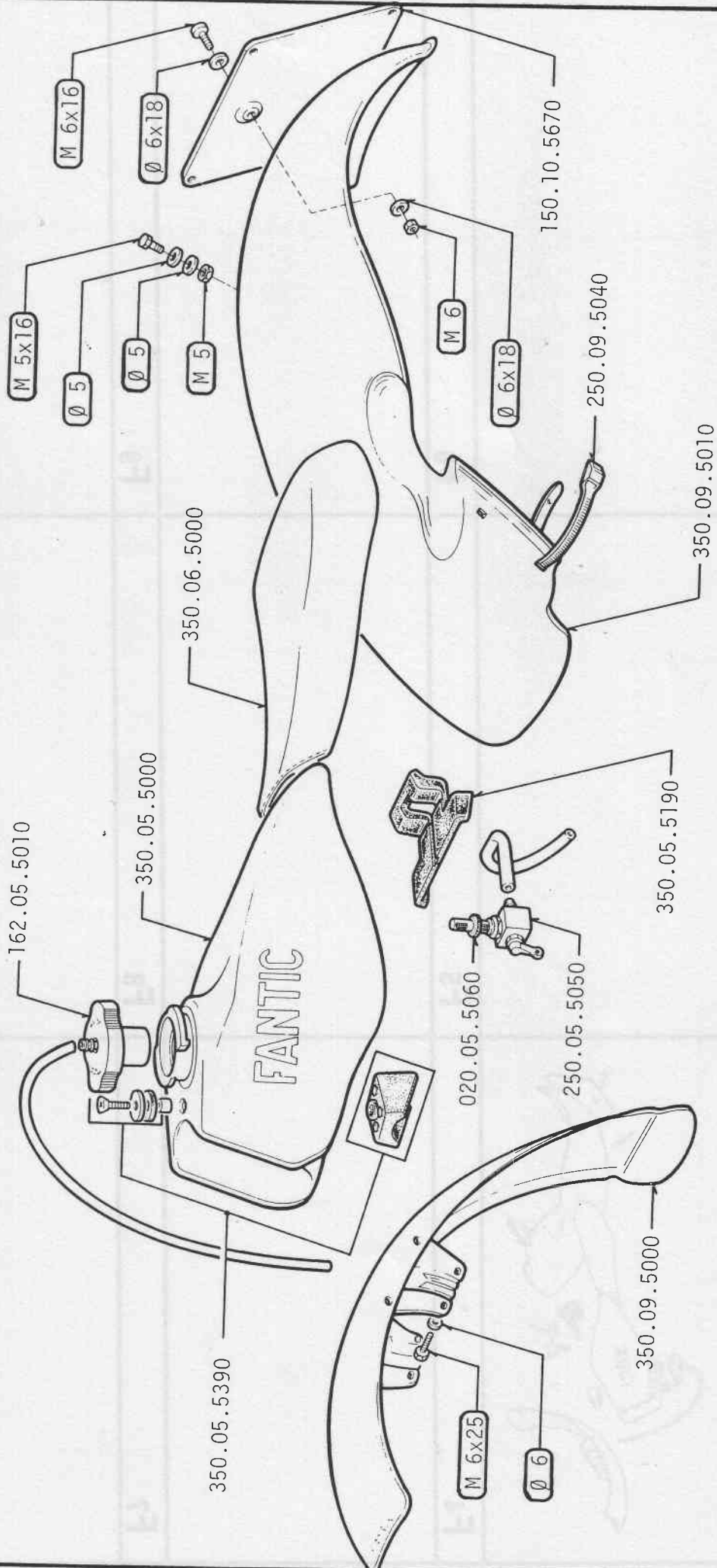

**SD** 350.17.6750

**G**

TRIAL 200

11 - 1979

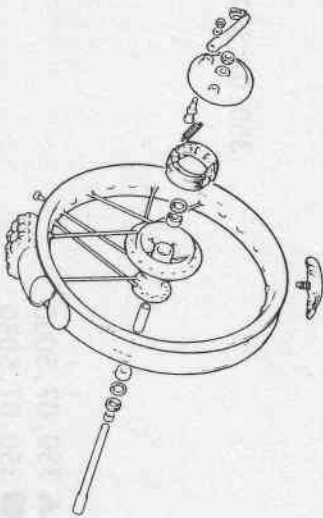
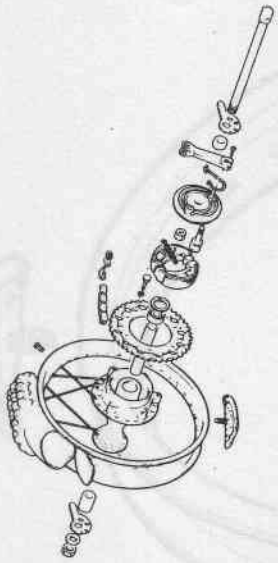
RUOTA ANTERIORE - RUOTA POSTERIORE  
ROUE AVANT - ROUE ARRIERE  
FRONT WHEEL - REAR WHEEL  
VORDERRAD - HINTERRAD**FANTIC  
FMOTOR****G1****G4****G2****G5****G6****G7****G8****G9**

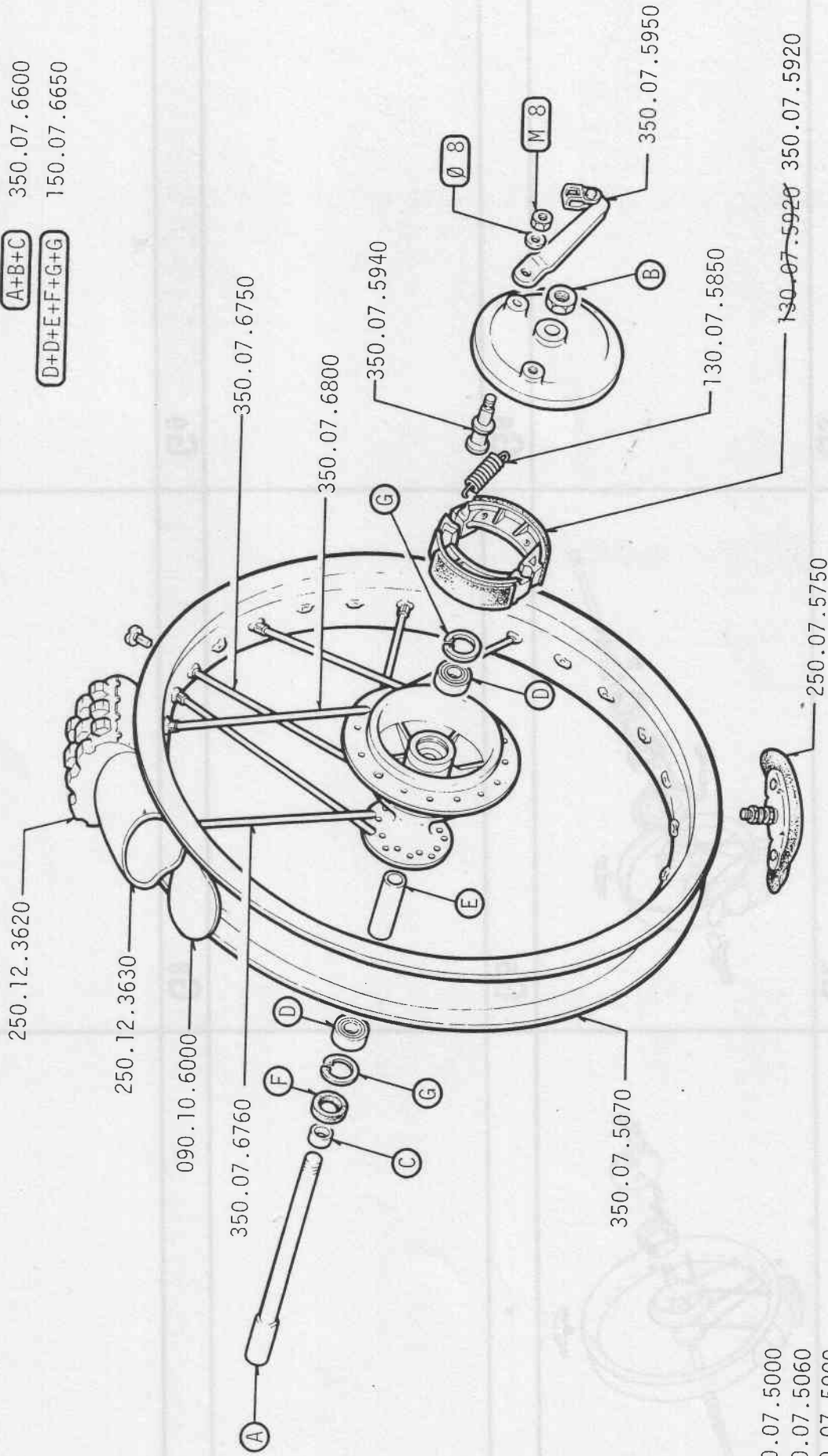

- ▲ Ruota anteriore completa
- Mozzo anteriore completo
- Disco portaceppi completo

- ▲ Roue avant complète
- Moyeu avant complet
- Disque porte-machoières complet

- ▲ Front wheel complete
- Front hub complete
- Front brake plate complete

- ▲ Vorderrad Komplett
- Vorderradnabe Komplett
- Bremsplatte Komplett

# G2

TRIAL 200

11 - 1979

# G

2/1

# FANTIC FMOTOR

**A+B+C+D+E** 350.07.6610

**F+G+F+H** 350.07.6660

250.12.3600

250.12.3610

350.07.6810

350.08.6720

351.08.6720+

350.07.6780

350.08.6360

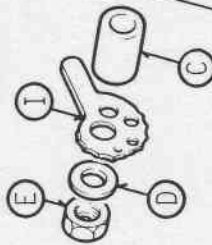

120.12.5100

160.07.5151

160.07.5760



945.03.0725

350.07.6710

**I+L**

350.08.6280



Ø 7

M 12

130.07.5920

350.07.5920

350.08.5960 Z=50

350.08.6000 Z=51

350.08.6010 Z=52

350.08.6020 Z=53

350.08.6030 Z=54

350.08.6040 Z=55

350.08.6050 Z=56

150.07.5940

130.07.5850

▲ 350.07.5290

■ 350.07.5300

● 350.07.5800

+ F ▲ Ruota posteriore completa  
 ■ Mozzo posteriore completo  
 ● Disco portaceppi posteriore completo

▲ Roue arrière complète  
 ■ Moyeu arrier complet  
 ● Disque porte-machoirs arrier complet

▲ Rear wheel complete  
 ■ Rear hub complete  
 ● Rear brake plate complete

▲ Hinterrad Komplet  
 ■ Hinterradnabe Komplet  
 ● Hinterradbremsplatte Komplet

**H**

TRIAL 200

11 - 1979

FARO ANTERIORE-FANALINO POSTERIORE-CABLAGGIO ELETTRICO  
 PHARE AVANT-FEU ROUGE-CABLAGE ELECTRIQUE  
 • HEAD LIGHT-TAIL LIGHT-WIRING HARNESS  
 VORDERER SCHEINWERFER-SCHLUSSLICHT-ELEKTRISCHE VERKABELUNG

**FANTIC  
FMOTOR**

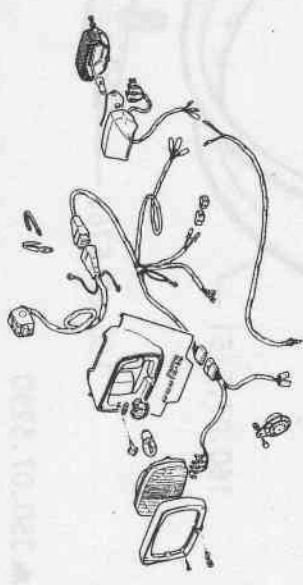
|  |           |           |
|--|-----------|-----------|
| <b>H1</b><br> | <b>H2</b> | <b>H3</b> |
| <b>H4</b>  | <b>H5</b> | <b>H6</b> |
| <b>H7</b>  | <b>H8</b> | <b>H9</b> |

# H1

TRIAL 200

11 - 1979

# H

1/1

# FANTIC FMOTOR

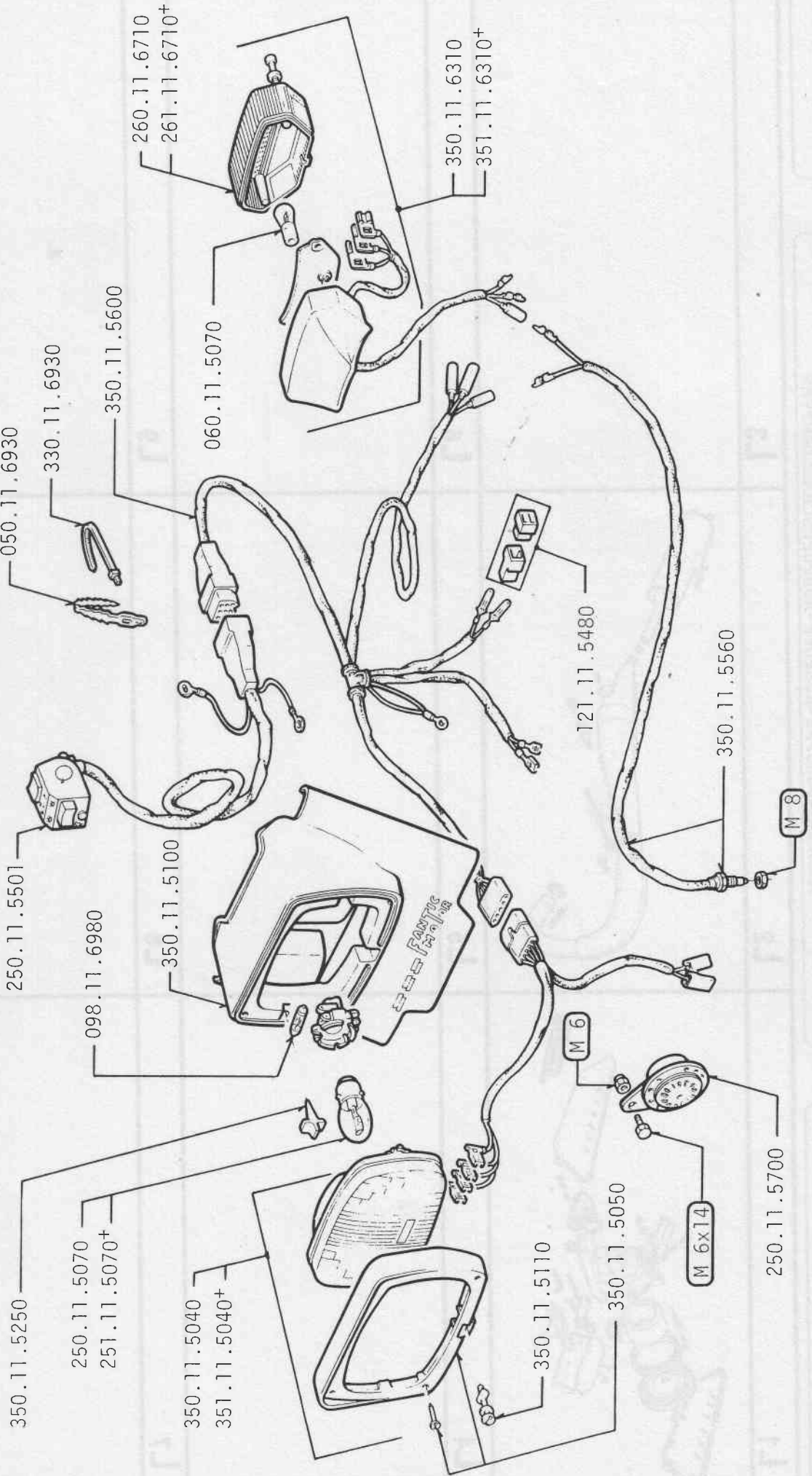

**L**

TRIAL 200

11 - 1979

GRUPPO ASPIRAZIONE-CAMERA D'ESPANSIONE-SILENZIATORE  
GROUPE ASPIRATION-POT D'ECHAPPEMENT-SILENCIEUX  
GROUPE INTAKE-SILENCER-TERMINAL SILENCER  
ANSAUGBAUGRUPPE-AUSPUFF-AUSPUFFSCHALLDÄMPFER

**FANTIG  
FMOTOR**

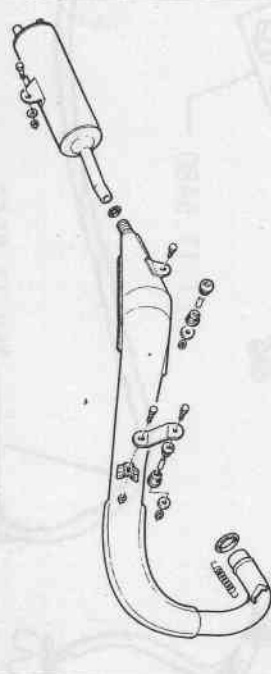
|  |   |                  |
|--|---|------------------|
| <p><b>L1</b></p>  | <p><b>L2</b></p>  | <p><b>L3</b></p> |
| <p><b>L4</b></p>   | <p><b>L5</b></p>  | <p><b>L6</b></p> |
| <p><b>L7</b></p>   | <p><b>L8</b></p>  | <p><b>L9</b></p> |

**L1**

TRIAL 200

11 - 1979

**L**

1/1

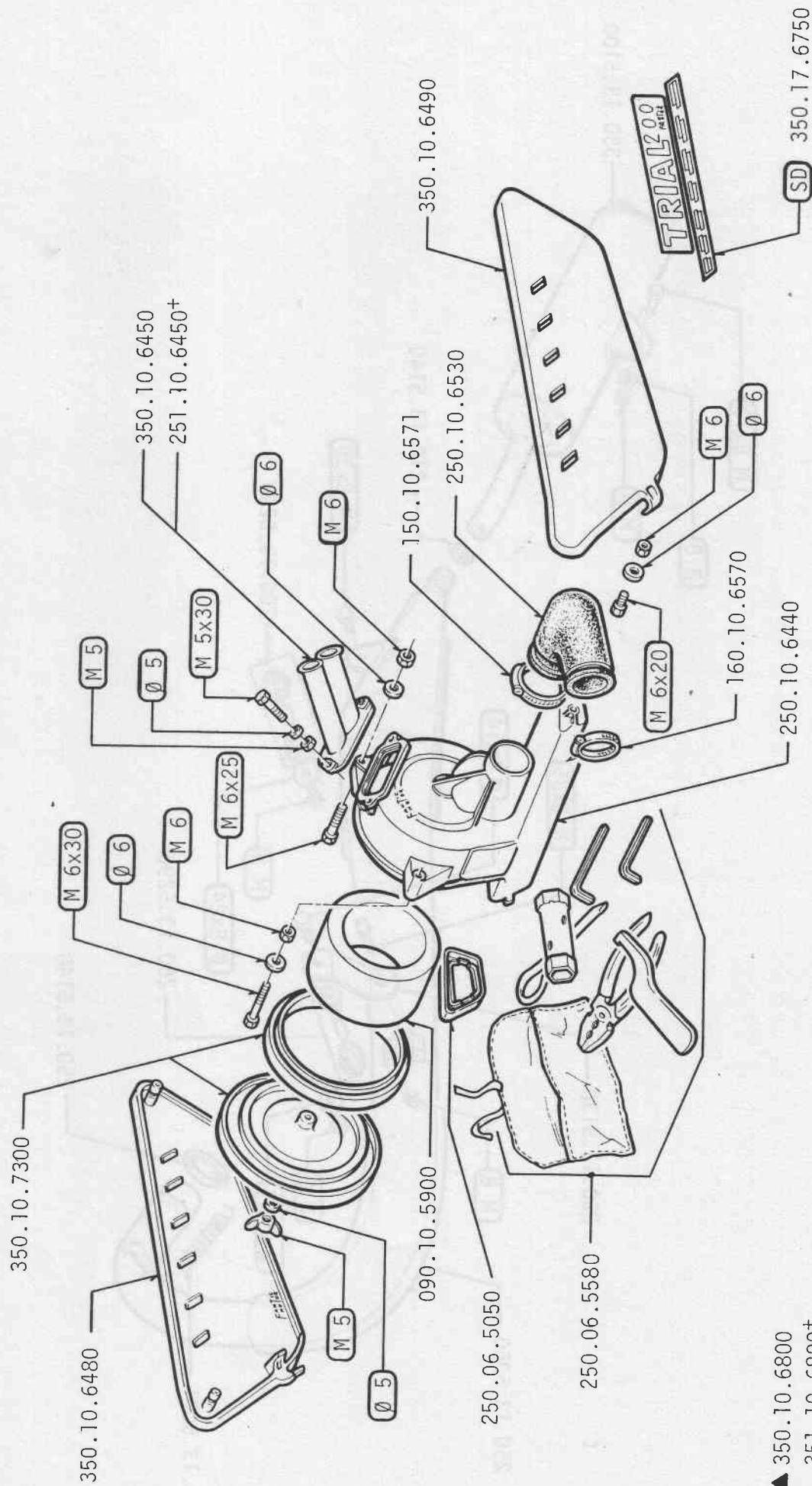
**FANTIC  
FMOTOR**

▲ 350.10.6800  
351.10.6800+

+ F ▲ Gruppo di aspirazione completo

▲ Groupe aspiration complet

▲ Group intake assembly

▲ Ansaugbaugruppe Komplet

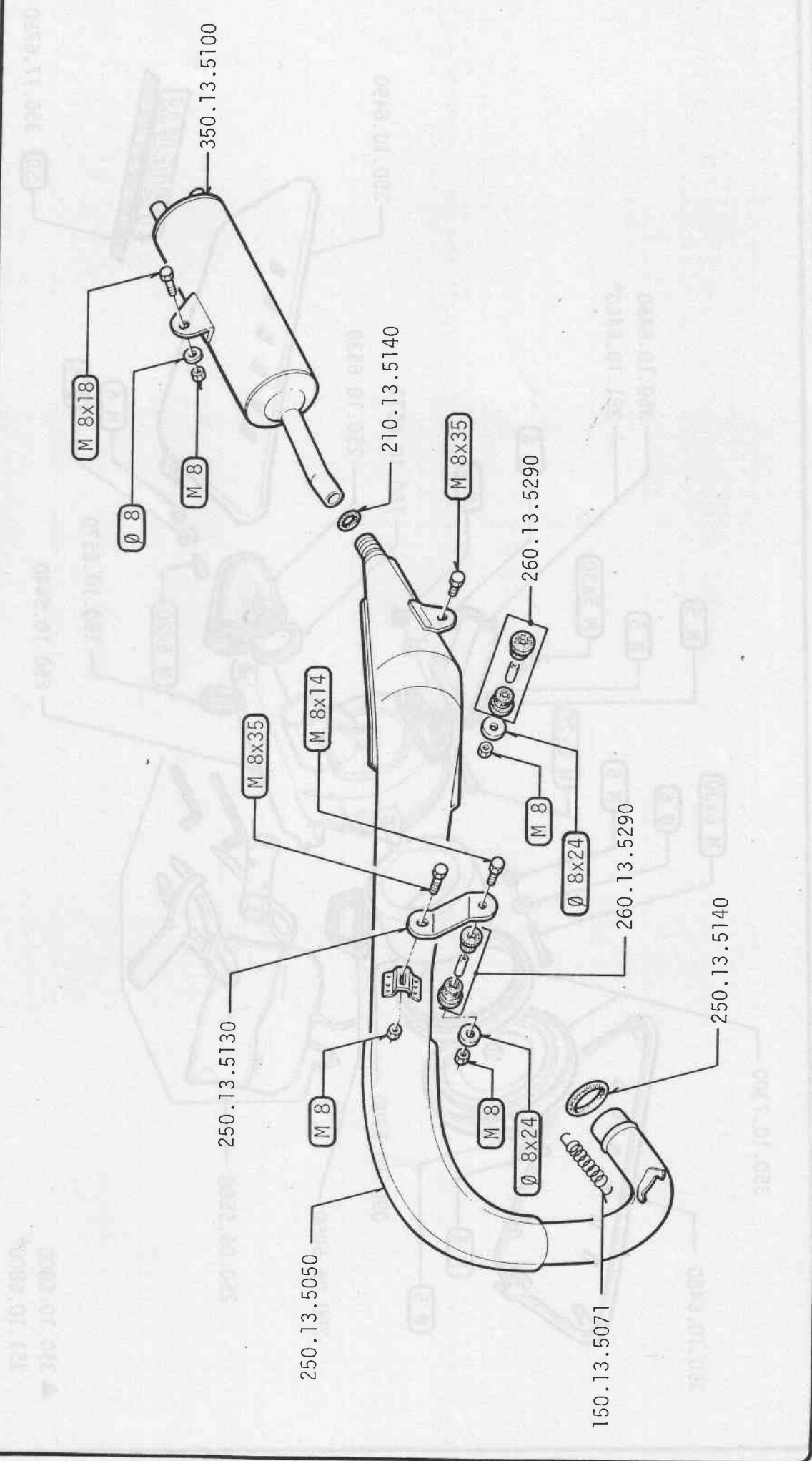

**M**

TRIAL 200

11 - 1979

CCONTACHILOMETRI - SELLA DOPPIA - SPECCHIETTO RETROVISORE  
 COMPTEUR-SELLE DOUBLE-RETROVISEUR  
 SPEEDOMETER-DUAL SEAT-REAR VIEW MIRROR  
 TACHOMETER-SITZBANK DOPPELT-RUCKSPIEGEL

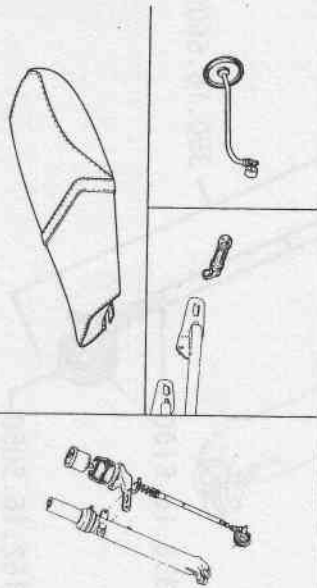
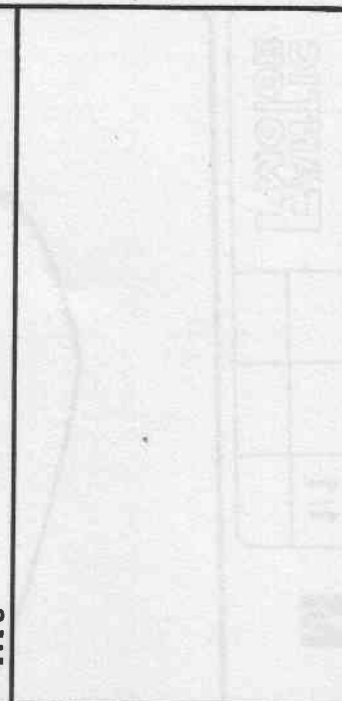
**FANTIC  
FMOTOR****M1****M2****M3****M4****M5****M6****M7****M8****M9**

# M1

TRIAL 200

11 - 1979

# M

1/1

# FANTIC FMOTOR

220.10.5650

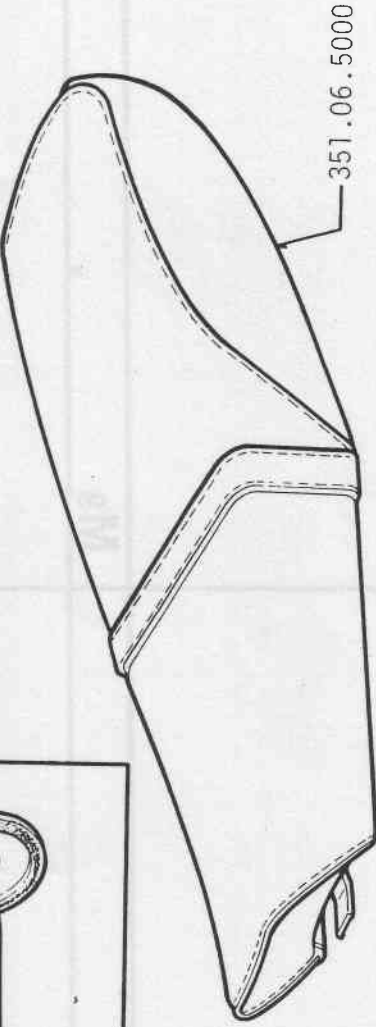
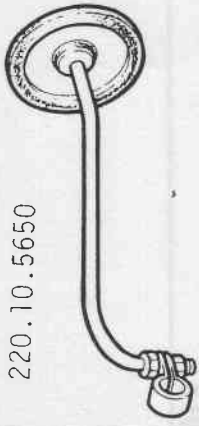

351.06.5000

350.16.5600

330.16.6160

350.16.7080

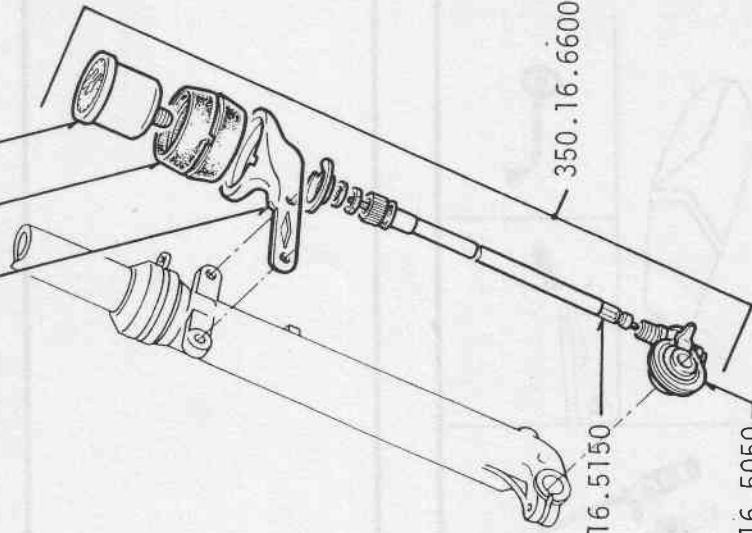

350.16.6600

350.16.5150

162.16.5050

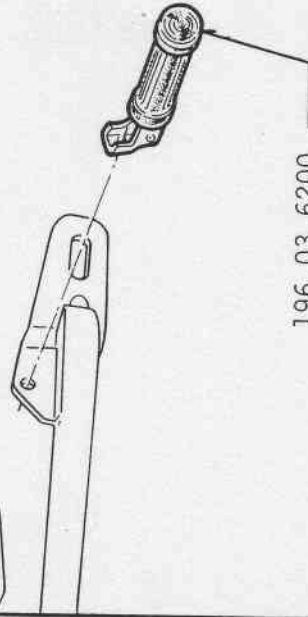

196.03.6200

- ▲ 350.16.5400
- 350.16.5403
- 350.16.5407

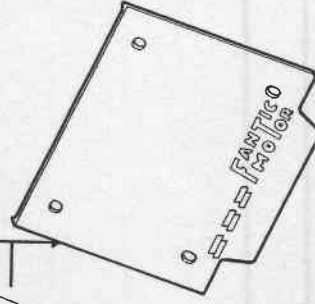

- ▲ Rosso
- Giallo
- Bianco

- ▲ Rouge
- Jaune
- Blanc

- ▲ Red
- Yellow
- White

- ▲ Rot
- Gelb
- Weiss

**N**

TRIAL 200

11 - 1979

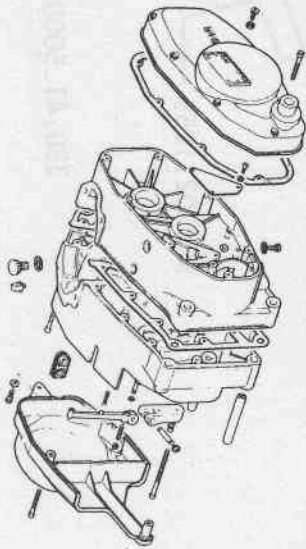
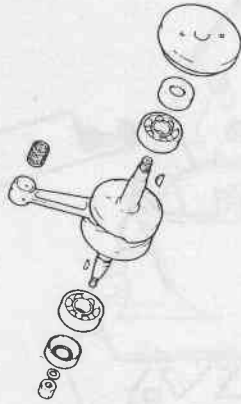
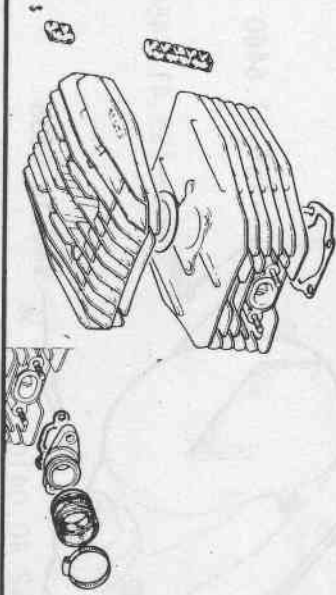
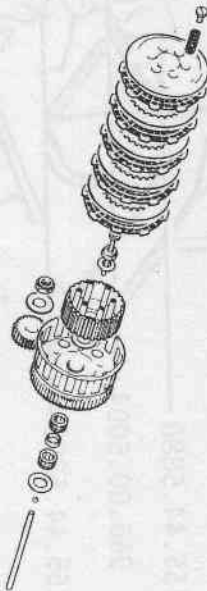
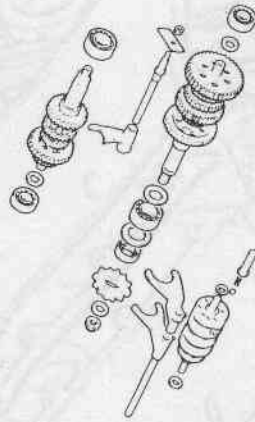
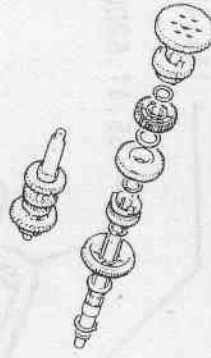
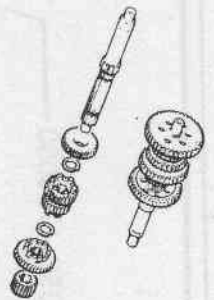
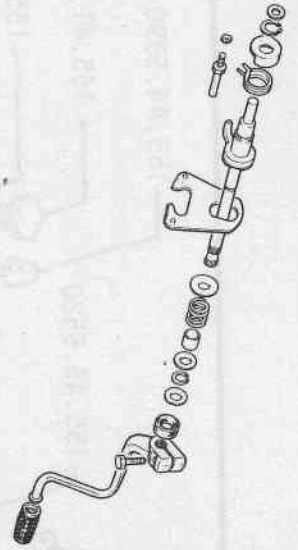
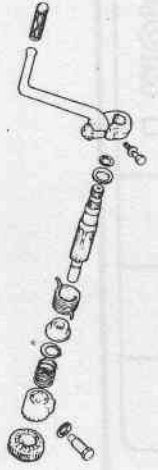
MOTORE  
MOTEUR  
ENGINE  
MOTOR**FANTIC  
FMOTOR****N1****N2****N3****N4****N5****N6****N7****N8****N9**



# N2

TRIAL 200

11 - 1979

# N

2/1

# FANTIG FMOTOR

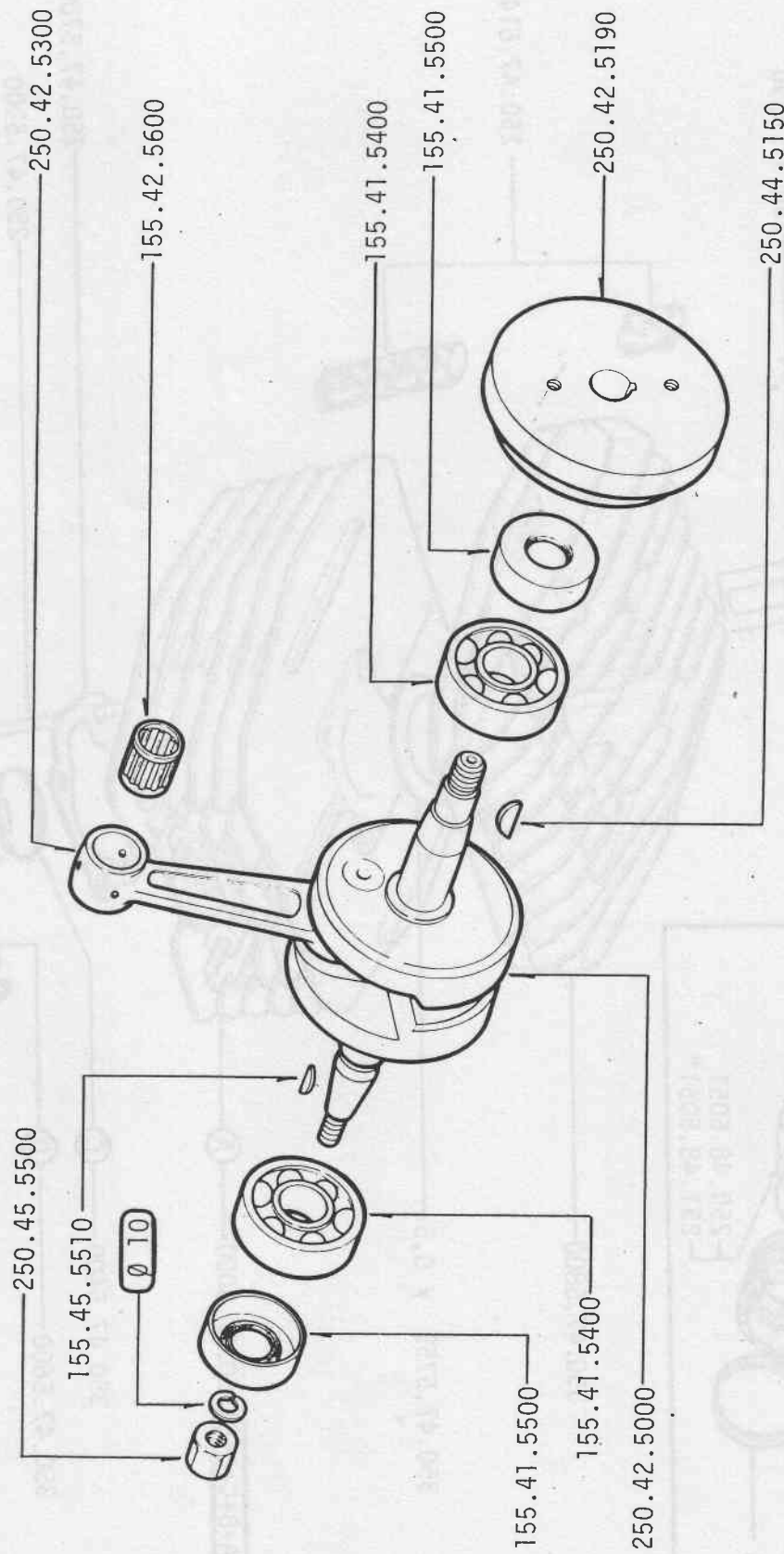

**SP** 260.41.6260

# N3

TRIAL 200

11 - 1979

# N

3/1

# FANTIC FMOTOR

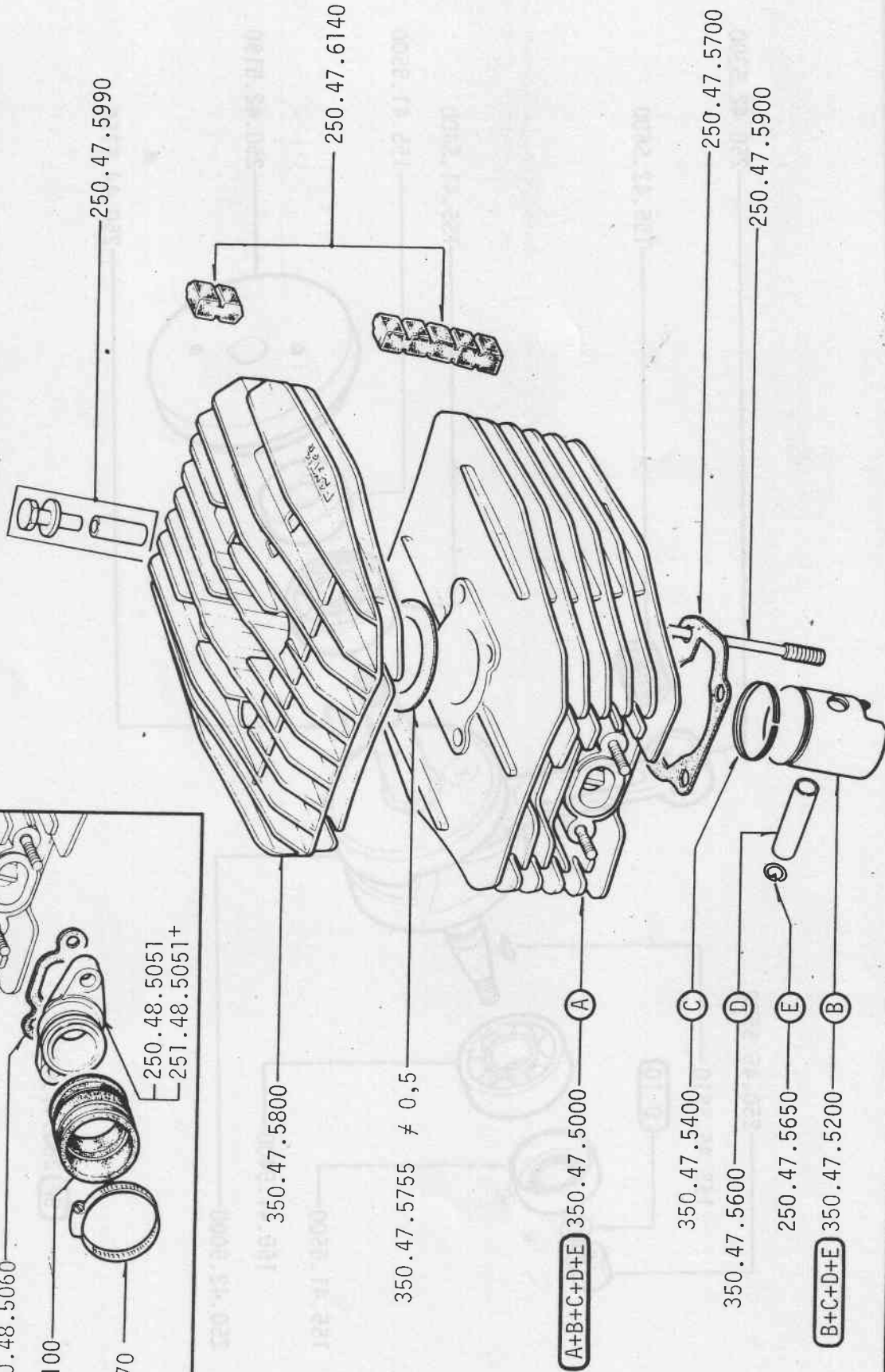
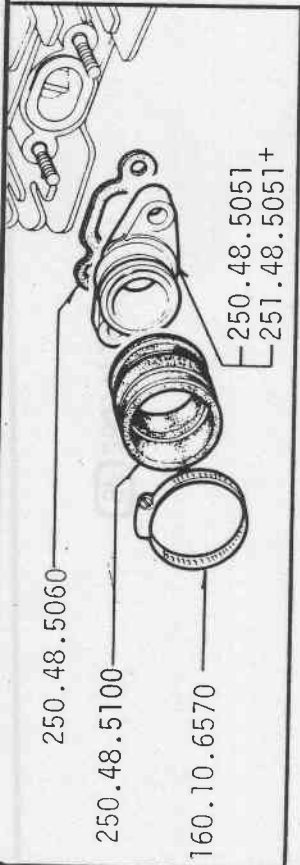

+ F

# M5

44-1816

180V 500

# FANTIC FMOTOR

# M

5/1

**N4**

TRIAL 200

11 - 1979

**N**

4/1

**FANTIC  
FMOTOR**

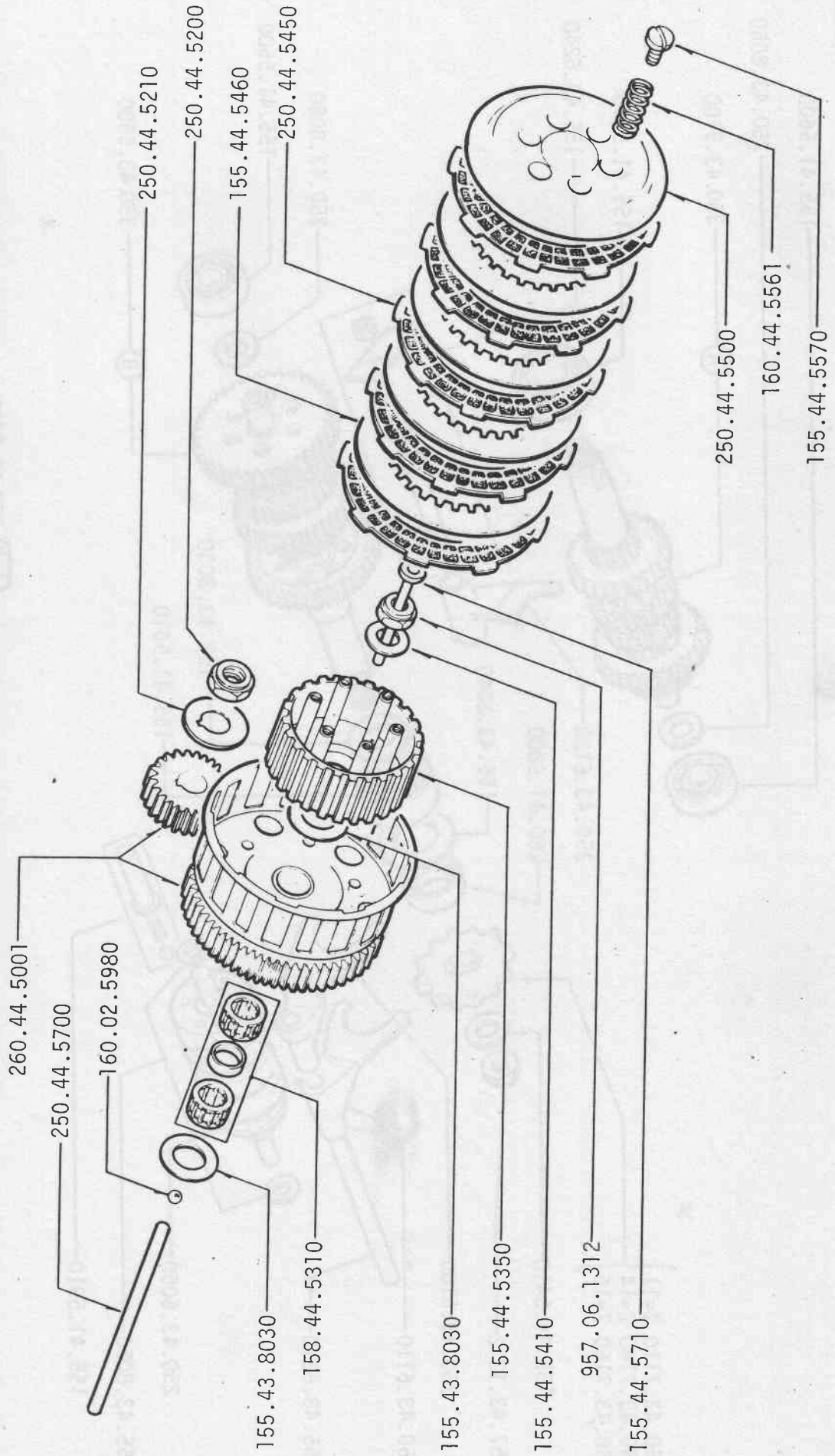

U-1838  
LIGHT 500

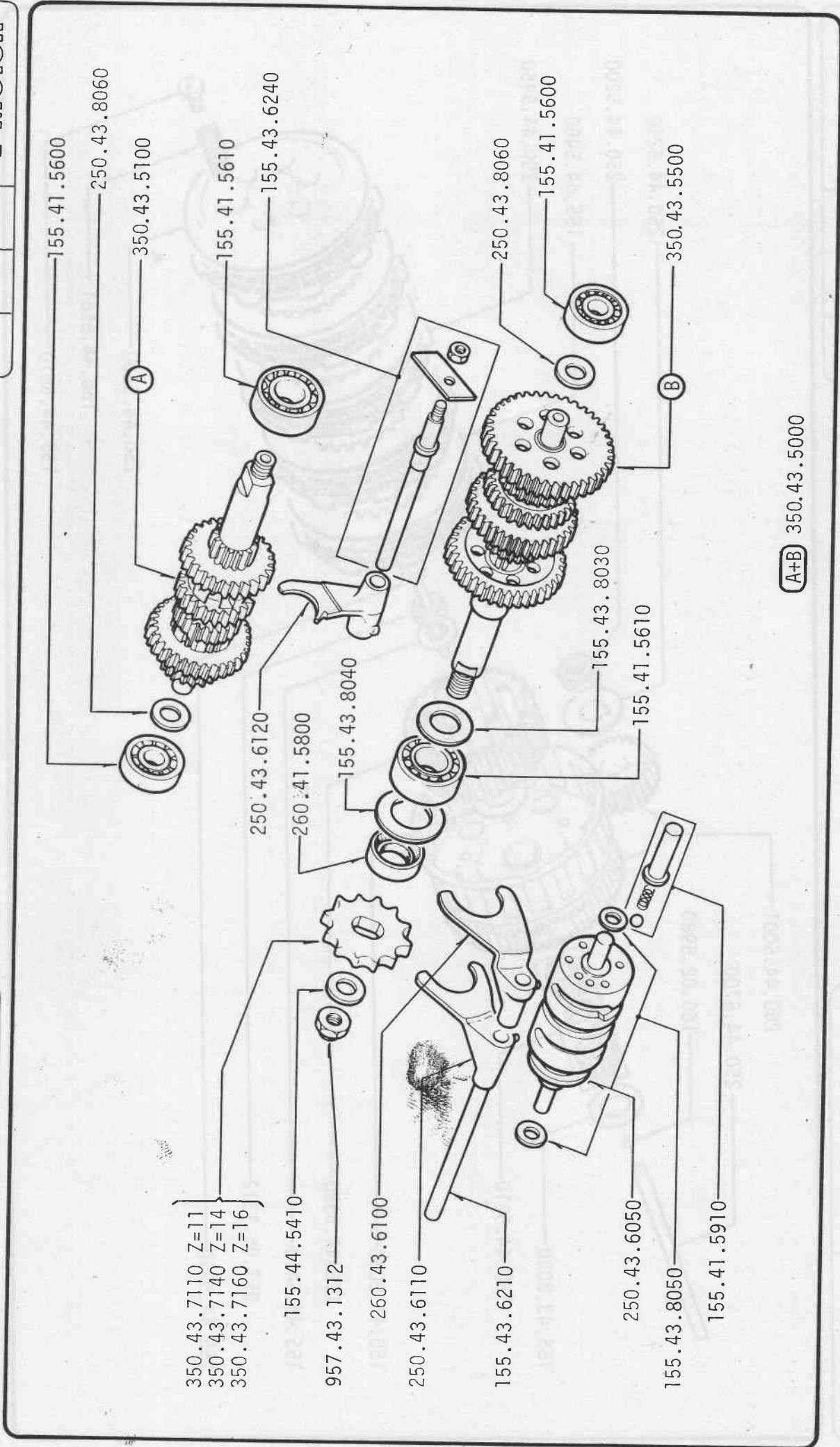

**A+B** 350.43.5000



# N7

TRIAL 200

11 - 1979

# N

7/1

# FANTIC FMOTOR

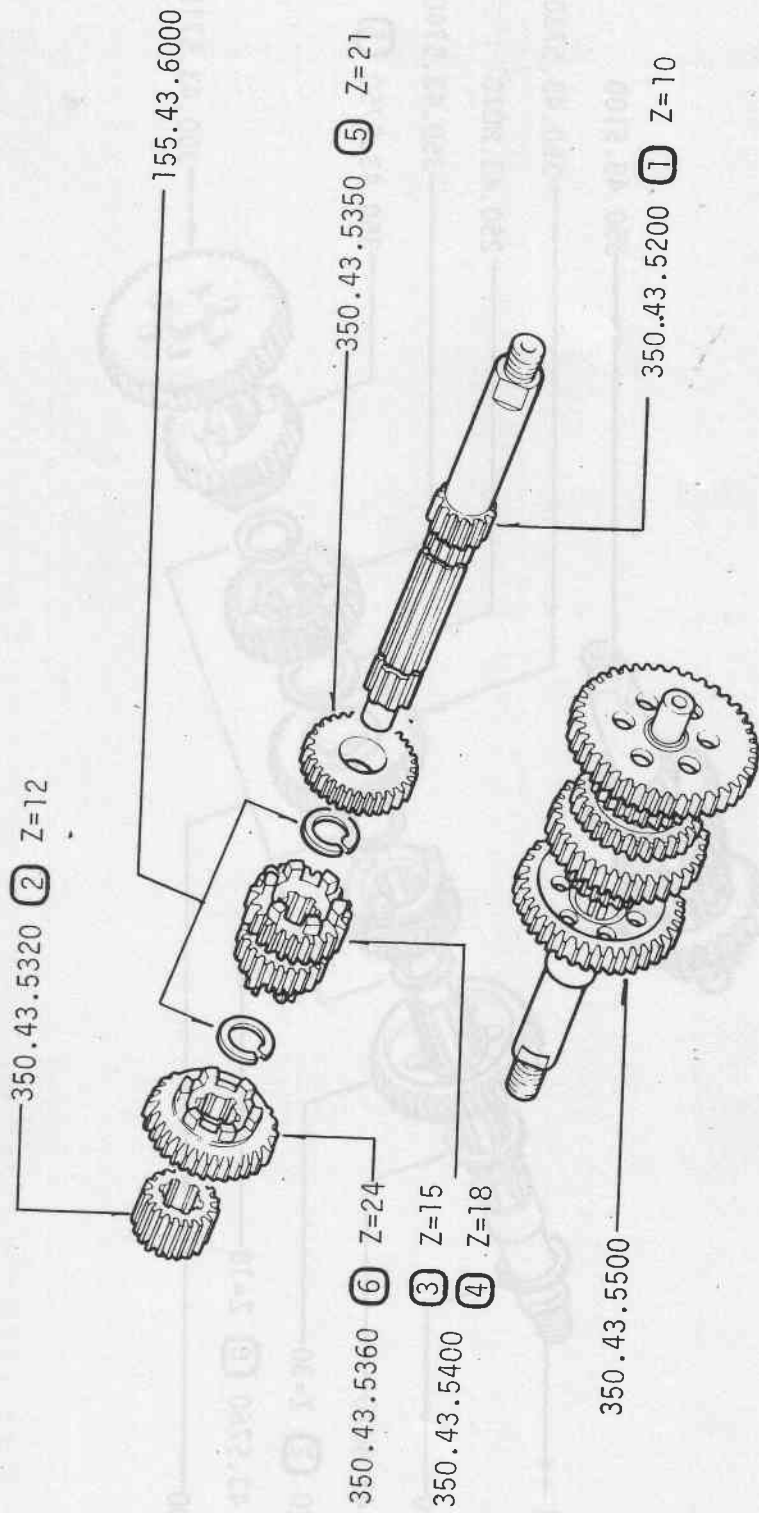

# Me

11-1979

TRIAL 200

# M

0/1

# FANTIC

**N8**

TRIAL 200

11 - 1979

**N**

8/1

**FANTIC  
FMOTOR**

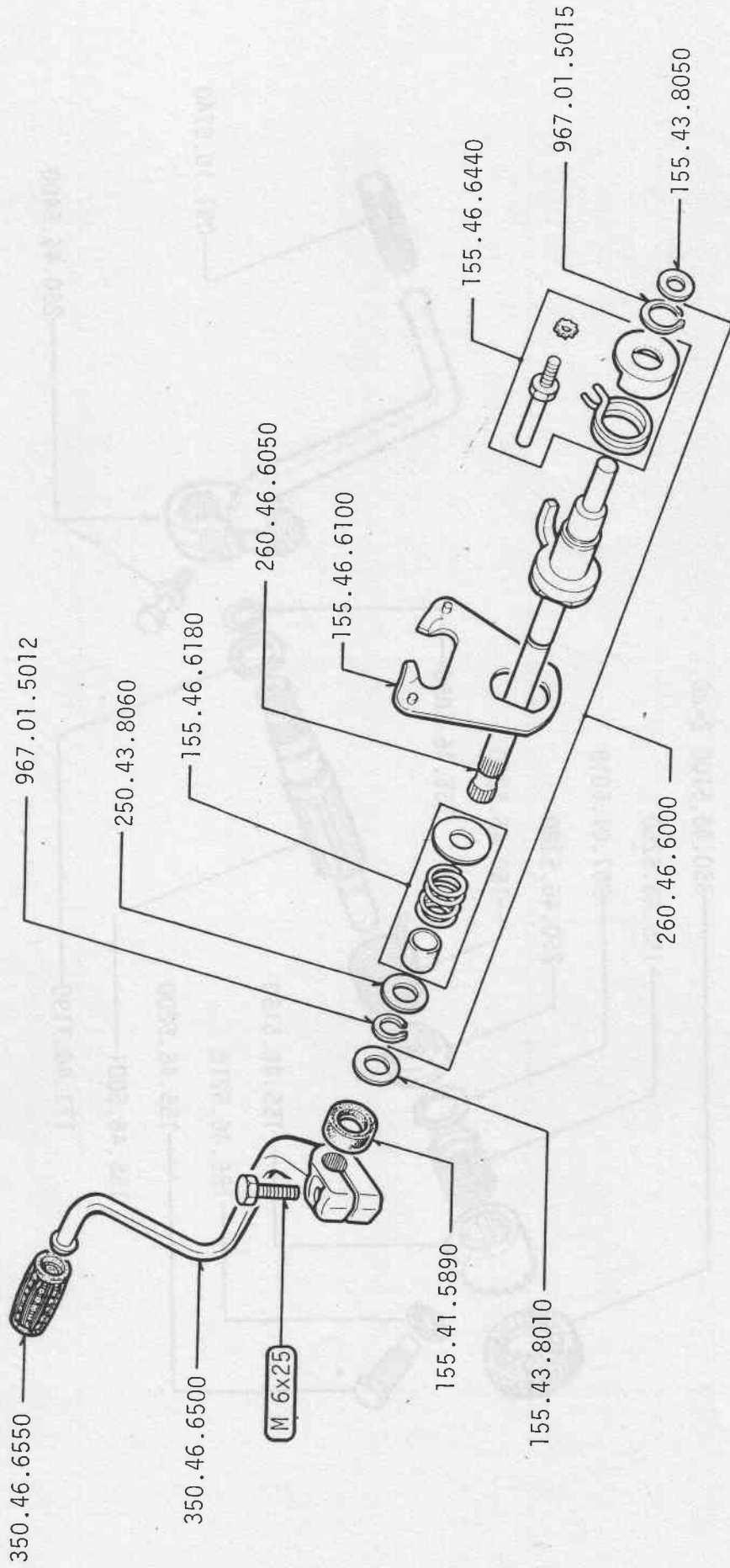

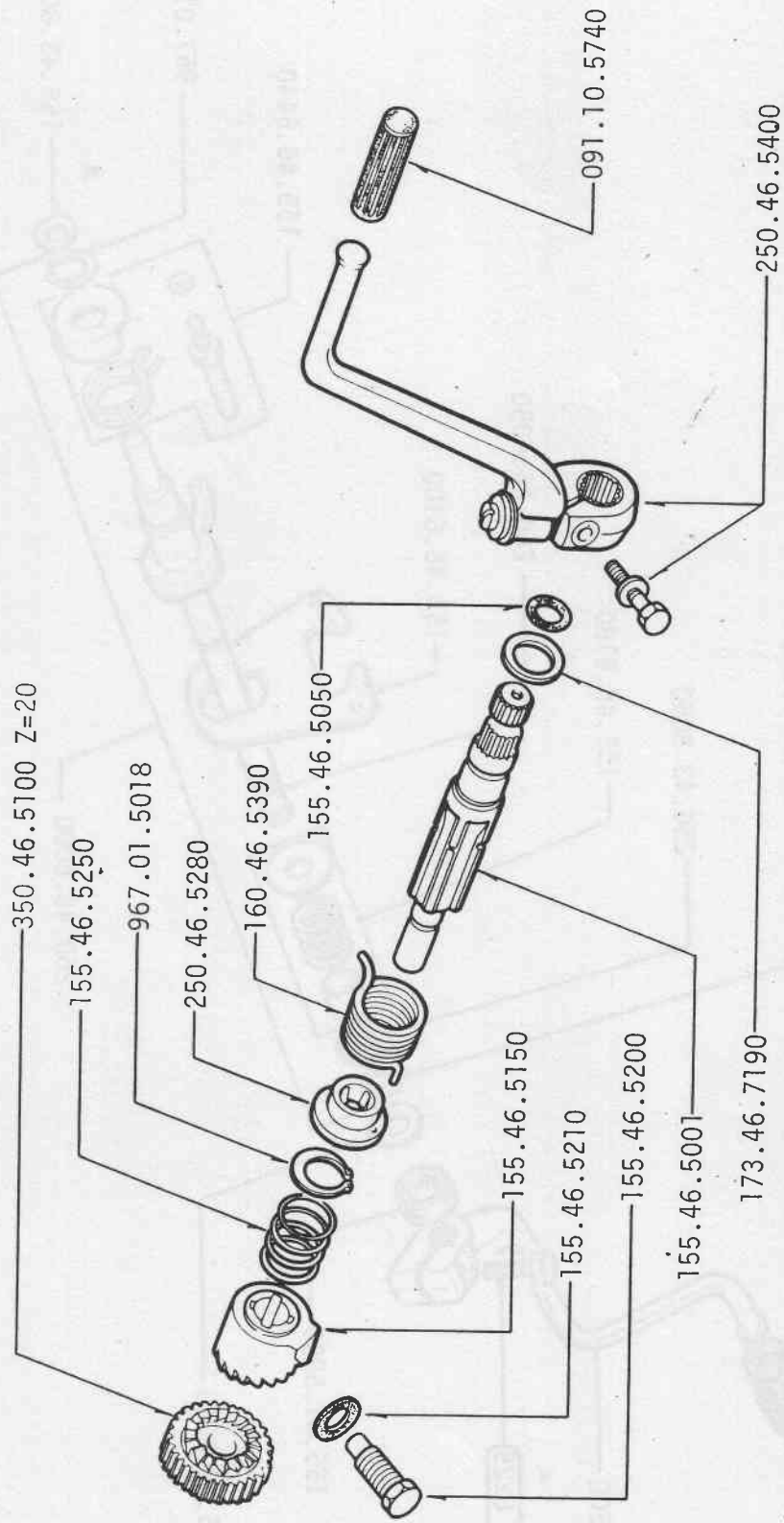





TRIAL 200

11 - 1979

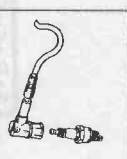
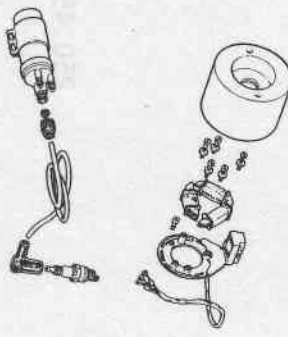
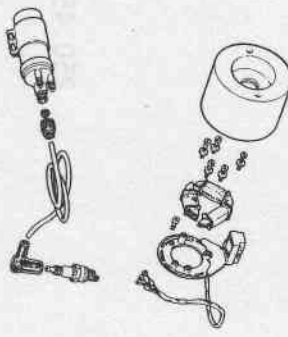

GRUPPO ACCENSIONE  
GROUPE ALLUMAGE  
IGNITION GROUPE  
ZÜNDANLAGE

FANTIC  
FMOTOR

|   |   |   |
|---|---|---|
| 01  | 02  | 03  |
|  |    |    |
| 04  | 05  | 06  |
|   |    |    |
| 07  | 08  | 09  |
|   |  |  |

**O1**

TRIAL 200

11 - 1979

**O**

1/1

**FANTIC  
FMOTOR**

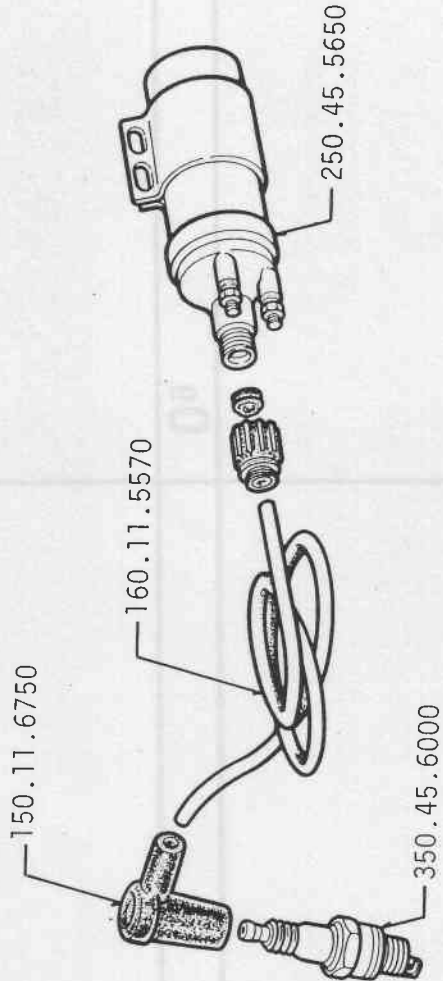
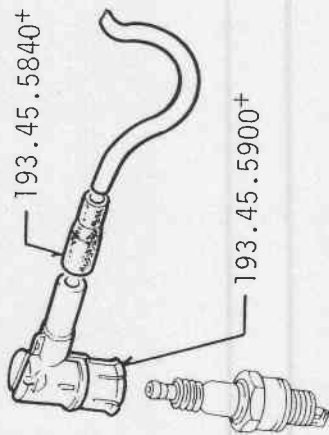

250.45.5110 — A

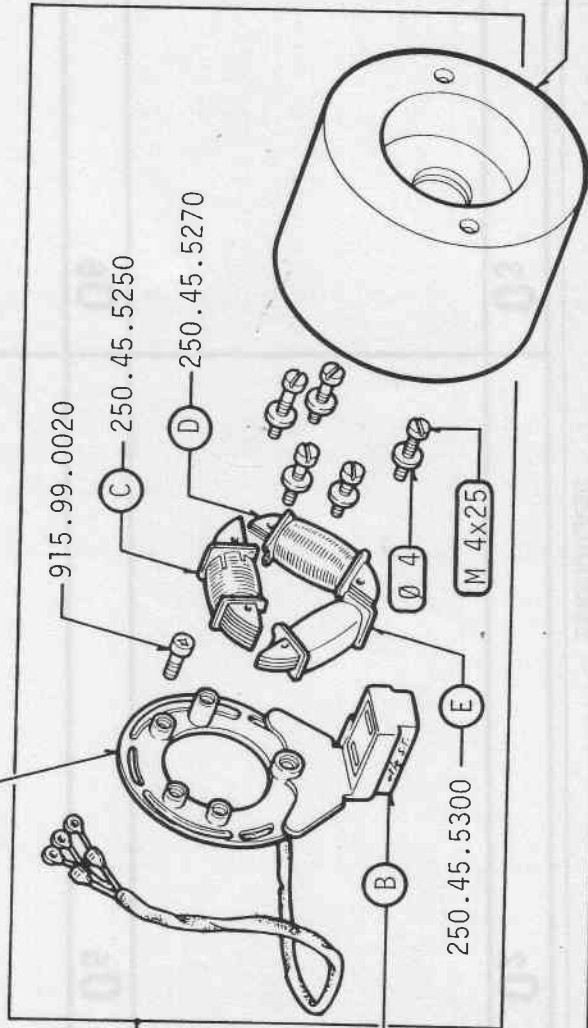

A+B+C+D+E

250.45.5100

+ F

**P**

TRIAL 200

11 - 1979

CARBURATORE  
CARBURATEUR  
CARBURETTOR  
VERGASER

**FANTIG  
FMOTOR**

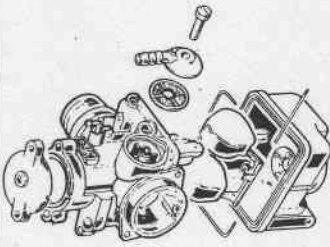
|  |                  |                  |
|--|------------------|------------------|
| <p><b>P1</b></p>  | <p><b>P2</b></p> | <p><b>P3</b></p> |
| <p><b>P4</b></p>   | <p><b>P5</b></p> | <p><b>P6</b></p> |
| <p><b>P7</b></p>   | <p><b>P8</b></p> | <p><b>P9</b></p> |

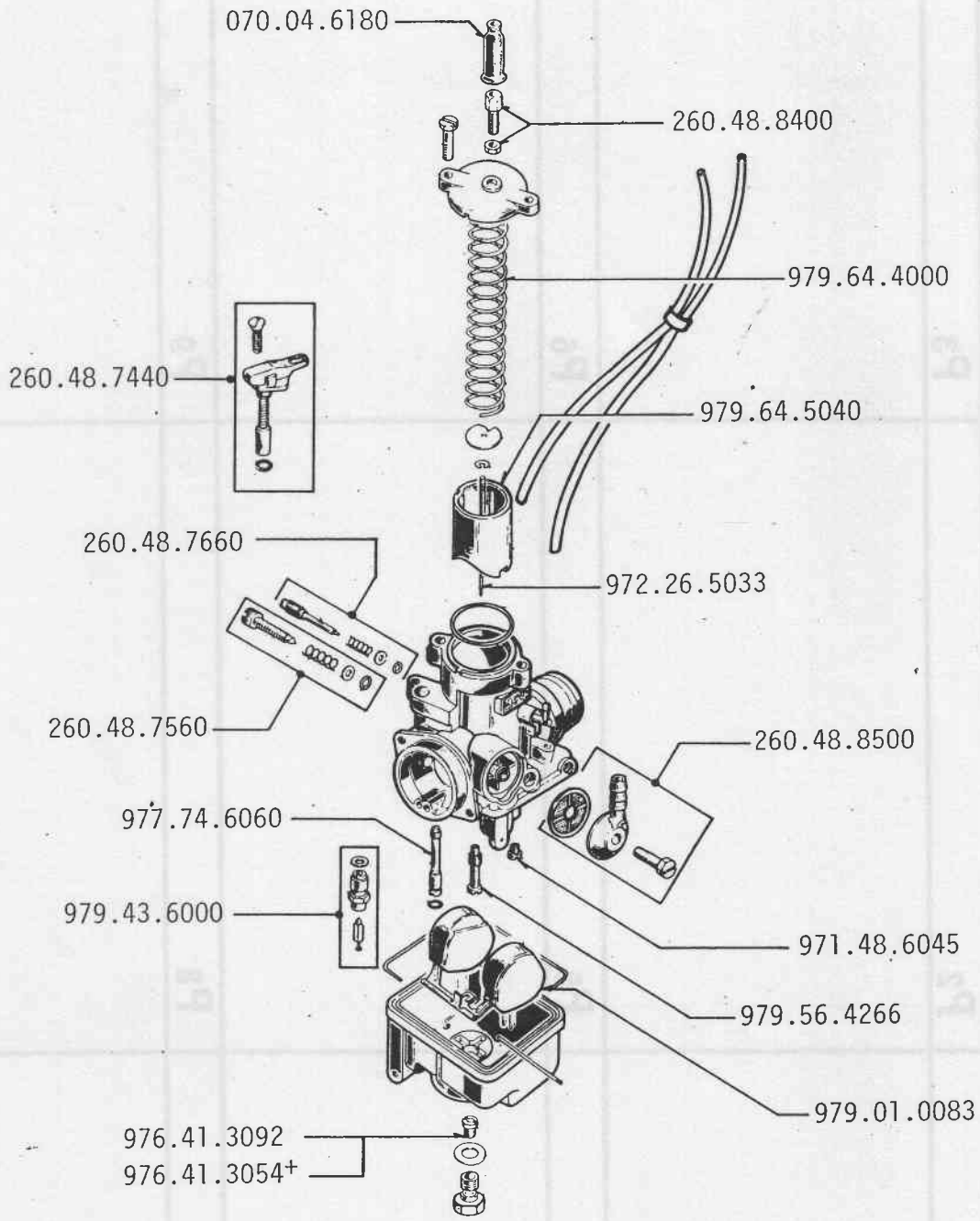

(SG) 250.48.5040

▲ 350.48.5000  
351.48.5000+

▲ Vergaser Komplet

▲ Carburettor complet

▲ Carburateur complet

▲ Carburatore completo